

LED Shoebox lamp accessories installation instructions

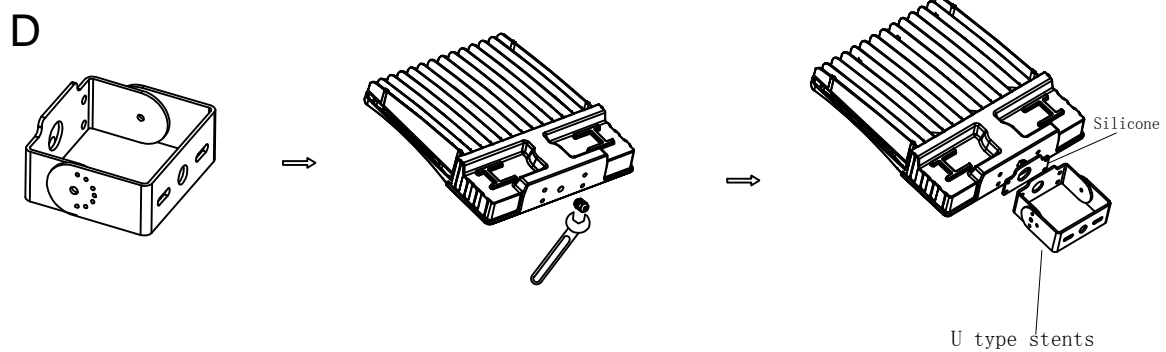

Installation

1. Install Arm adaptor on the lamp and tighten the adjusting angle screw for the axle hole. (as shown)
2. Install attachments and tighten screws according to the sequence of the explosions. (as shown)

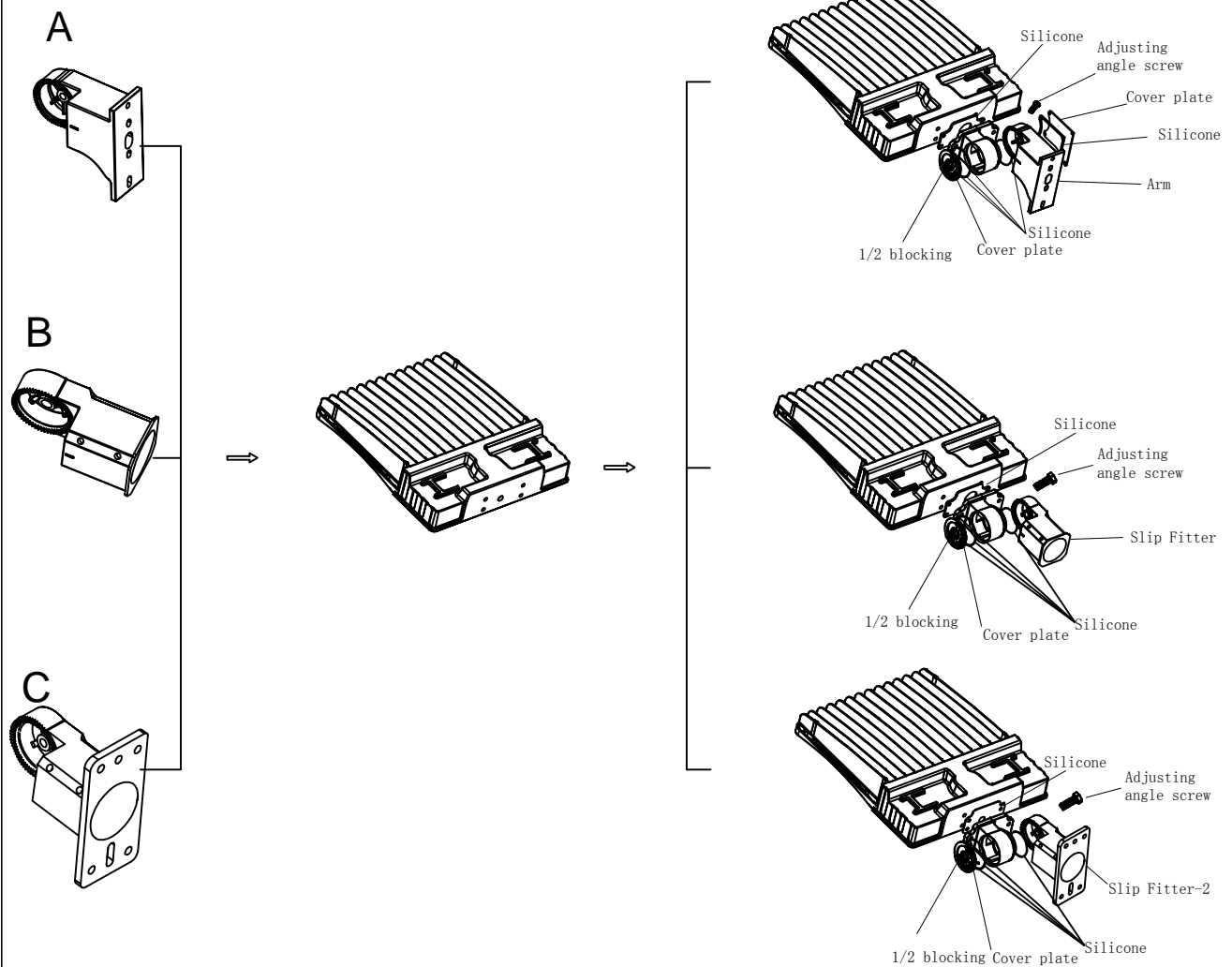
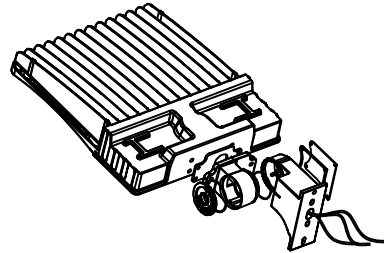
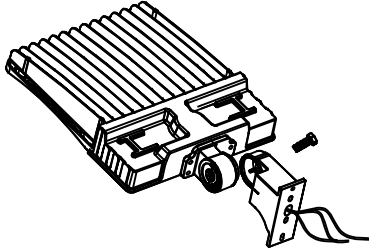

1. Install the slipfitter adapter on the lamp and tighten the adjusting angle screw of the axle hole. (as shown)
2. Install accessories according to explosive sequence and tighten screws. (as shown)

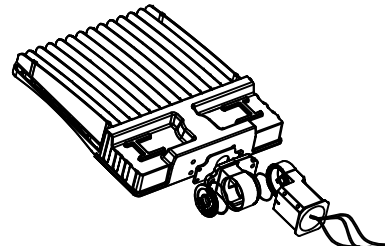
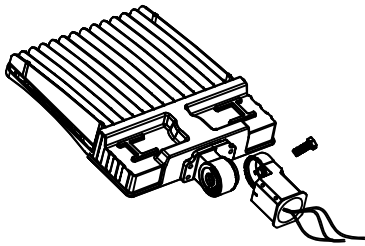

1. Install the slipfitter-2 adapter on the LED shoebox and fix it with four screws.
2. Install accessories and tighten screws according to exploded pictures. (as shown)

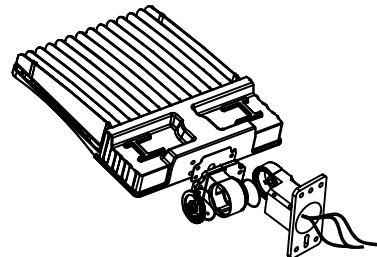
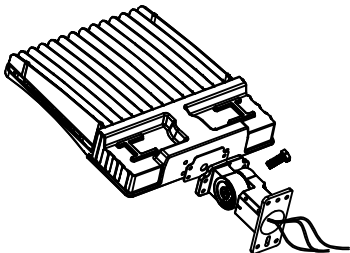

1. Install the waterproof connector and tighten it with a wrench.
2. Install the U bracket of the lamp to the luminaire and tighten the screws. (as shown).
3. Install another U bracket on the luminaire and tighten the rotary screw and the positioning angle screw. (as shown)

